

IKO



experts in
MOTION

Bearing and Linear Motion Technology

2020

Guide to **IKO** Product Catalogs

CAT-5796US

The designs you create and solutions you discover will move your business forward, helping you break through with bold new ideas and achievements never before realized and transforming the face of your industry.

At IKO, our mechanical parts are but a small piece of the success you achieve. Relying on our quality and innovation will allow you to design more freely and with confidence, expanding the possibilities of your business.

Within this book are the elements you need to help you design the future. We are proud to be your partner in this journey. Together we can change and improve not only your business, but the world itself for future generations.



Products:

- Bearings
- Linear Motion Rolling Guides
- Precision Positioning Tables



*Enormous Potential
in Every Single Movement*

Bearings

As one of the worlds leading manufacturers of Needle Roller Bearings, **IKO** boasts an excellent track record in both quality and wide product range. In fact, we were the first company in Japan to initiate the technical development of Needle Roller Bearings, making them into the machine components that are now indispensable to the manufacturing industry. Today, we also produce many other bearing products that meet all types of requirements for a variety of industries.

Needle Roller Bearings	5
Crossed Roller Bearings	7
Slim Type Crossed Roller Bearings	9
Hex Head Cam Followers	11
Cam Followers & Roller Followers	13
Maintenance Free C-Lube Bearings	17
Needle Roller Cages for Engine Connecting Rods	19
Spherical Bushings & PILLOBALLs	20



Needle Roller Bearings

General Catalog



For more information on all  Needle Roller Bearings in this section, request catalog [CAT-1581E](#).

Standard Options ... Unique Solutions

IKK bearings are available in a range of sizes and types to meet the unique needs of most any application.

Benefits of Needle Roller Bearings

Compared to other roller bearings, IKK Needle Roller Bearings have the following advantages:

Low sectional height to withstand heavy loads

Since they have a low sectional height, IKK bearings can withstand heavy loads. Machines can be made more compact and lightweight, saving on cost.

Small rotating torque means improved mechanical efficiency

Since the rotating radius is small, the rotating torque is small as well under the same frictional conditions, improving mechanical efficiency.

Inertia is minimized

Since the bearing volume and weight are small, the moment of inertia of the bearing is minimized when it is put in motion.

Well suited for oscillating motion

Rolling elements are arranged at a small spacing pitch, making this configuration well suited for oscillating motion.

- Shell Type Needle Roller Bearing Series**
- Machined Type Needle Roller Bearing Series**
 - Cam Followers**
 - Roller Followers**
 - Needle Cages**
- Crossed Roller Bearings**
- Combined Type Needle Roller Bearing Series**
 - Spherical Bushings**
 - PILLOBALLS**





CRBH(V) / CRBF(V)

Crossed Roller Bearings





CRBH(V) / CRBF(V)

CAT-1581E

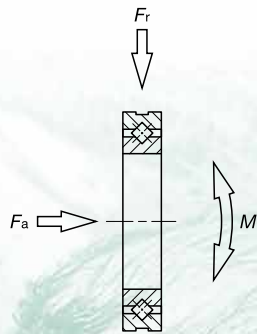

The Axis of Technology



 Crossed Roller Bearings are compact bearings with their rollers alternately crossed at right angles to each other between inner and outer rings. The rollers make line contact with raceway surfaces so elastic deformation due to bearing load is very small. They also handle loads from any direction at the same time, such as radial, thrust and moment loads. They can make your design compact as well when compared to using taper roller bearings and a combination of two ball bearings.

Crossed Roller Bearings are widely used in the rotating parts of industrial robots, machine tools, medical equipment, or any equipment that requires compactness, high rigidity and high rotational accuracy.

Features of Crossed Roller Bearings:

High load capacity and high-rigidity

Handles loads in any direction and moment loads at the same time

Compact to save space in your design

Mounting variations for greater design flexibility

Available bore diameter:
10 mm to 800 mm

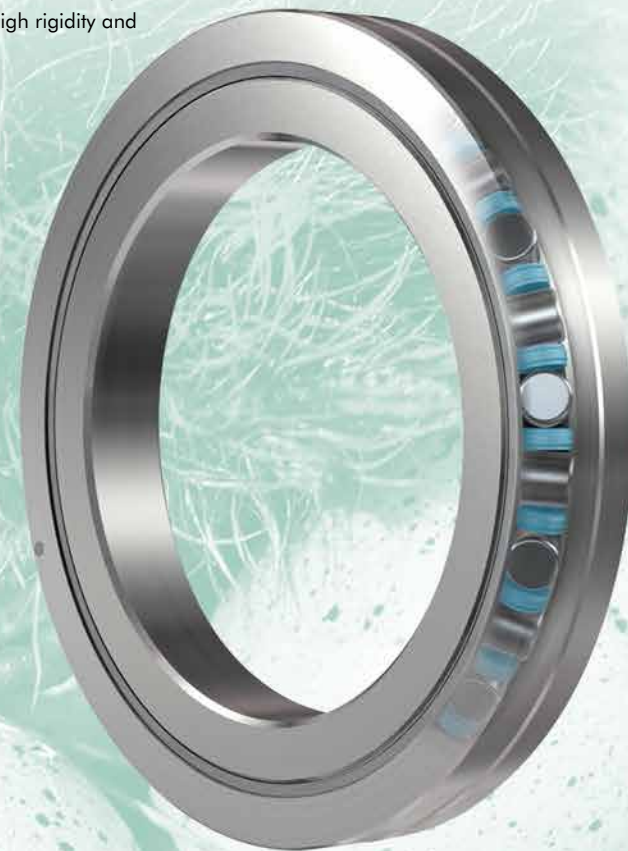



CRBS / CRBT

Slim Type Crossed Roller Bearings



CRBS / CRBT

CAT-1581E

World's Thinnest Crossed Roller Bearings

Features of Slim Type Crossed Roller Bearings

Very low cross sectional height of 5.5mm

The crossed sectional height is reduced by 69% compared to standard slim crossed roller bearings (bearing bore diameter 50mm).

The width is also smaller at just 5mm, and the cross sectional height is reduced by 43% compared to conventional products.



38% lighter in weight compared with conventional slim types

With mass ratio of just 0.38, there is a significant weight reduction compared with conventional slim type crossed roller bearings.





CF...B/CFES...B/CFE...B/CF...WB CF-SFU...B/CF...WB.../SG/NUCF...BR/CFKR

Hex Head Cam Followers

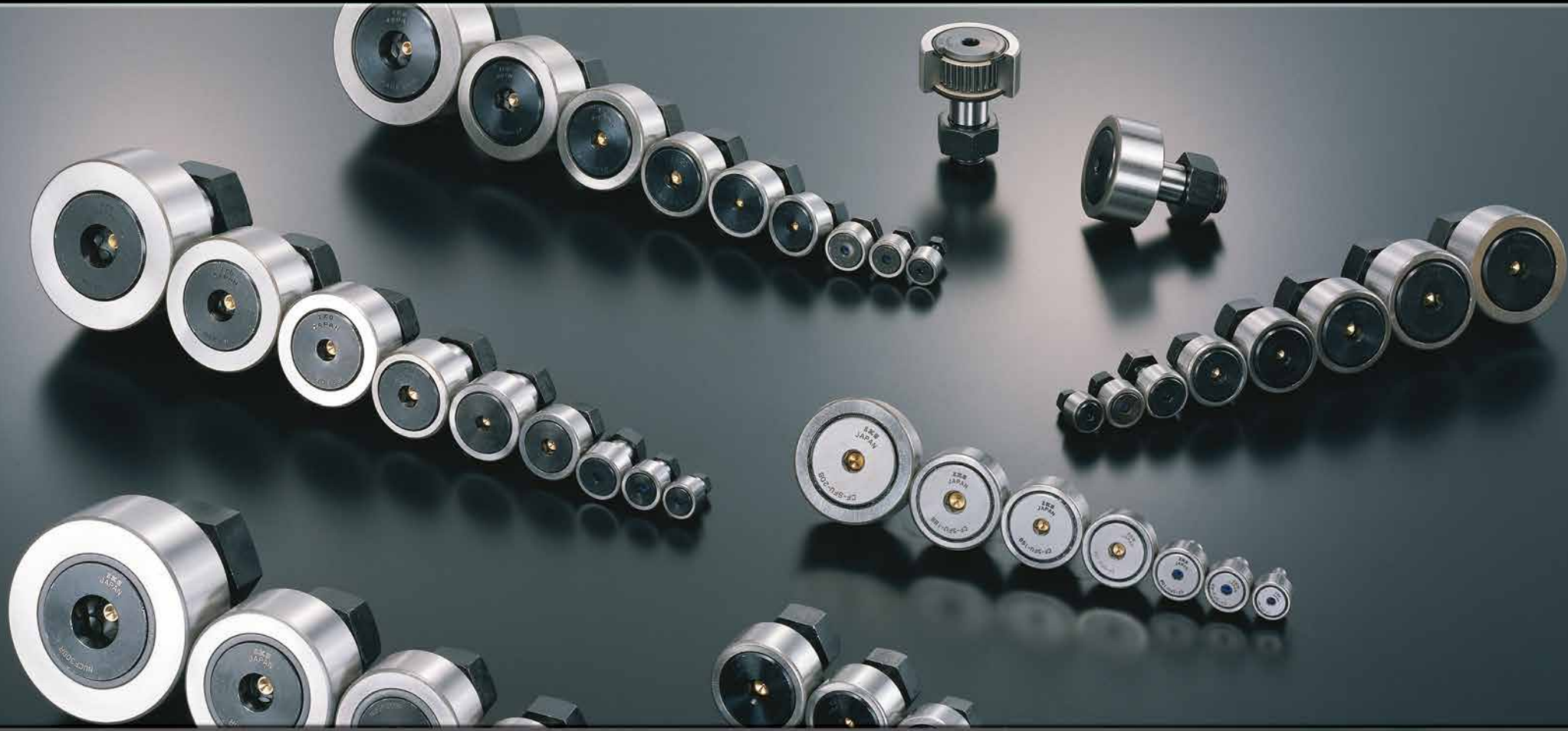

CAT-1582E

Easy Mounting and Easy Lubrication

Cam Followers are bearings for cam mechanisms that provide linear motion with high rigidity and high accuracy. They are widely used for machine tools, industrial robots, electronic devices and OA equipment. Hex Head Cam Followers can be fixed firmly with a hexagonal wrench and the re-lubrication can be done from three positions, providing easy assembly and easy maintenance for your applications.



Hex Head Cam Followers

Stud diameters of 5 mm to 30 mm are available

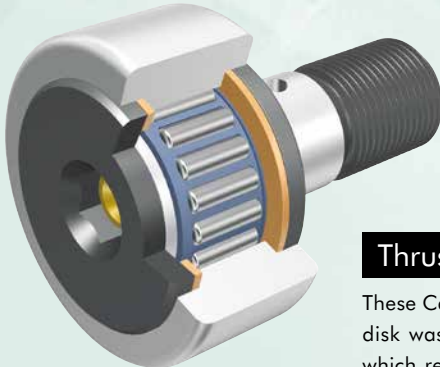

Thrust Disk Cam Followers

These Cam Followers have a special resin thrust disk washer between the cage and side plate which reduces extra friction and wear caused by misalignment.



Lubrication from three ways

Stud dia. 12 to 30mm

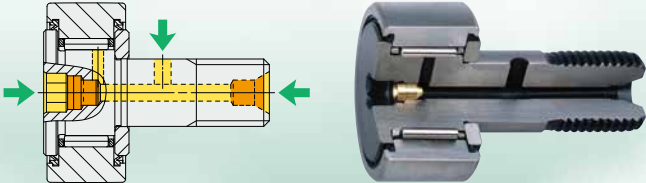

Lubrication from one way

Stud dia. 5 to 10mm

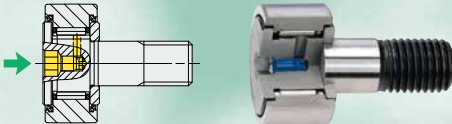



Cam Followers and Roller Followers

General Catalog



There are many different types and sizes of Cam and Roller Followers in both metric and inch dimensions.

Standard Cam Followers

Solid Eccentric Stud Type Cam Followers

Eccentric Type Cam Followers

Thrust Disk Type Cam Followers

Centralized Lubrication Type Cam Followers

Easy Mounting Type Cam Followers

Heavy Duty Type Cam Followers

Miniature Type Cam Followers

Thrust Disk Type Miniature Cam Followers

Inch Series Cam Followers

Maintenance Free C-Lube Cam Followers

Separable Roller Followers

Non-separable Roller Followers

Heavy Duty Type Roller Followers

Non-separable Roller Followers, Inch Series

CAT-1581E



Available stud diameter:

2 mm to 30 mm



CF-F

Stainless Steel Cam Followers



CAT-1582E

These Cam Followers are superior in corrosion resistance and suitable for applications when humidity/moisture is high.



CFES

Cam Followers Solid Eccentric Stud Type



CAT-1582E

The stud is eccentric to the center axis of the outer ring. Thus, the position of the outer ring can easily be aligned to the track surface simply by turning the stud.

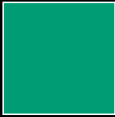

CF-RU1/FU1

Cam Followers for Centralized Lubrication
&

CF-SFU

Cam Followers for Easy Mounting



CAT-1582E

Centralized Lubrication Type has pipe threaded lubrication holes in the stud for easy connection to the system.
The Easy Mounting Type can save assembly time when used in pallet changers, etc.



CF...W

Cam Followers Thrust Disk Type



CAT-1582E

These cam followers incorporate a special resin thrust disk superior in wear and heat resistance, and are suitable under axial loads caused by misalignment, etc.

NUCF·NURT

Cam Followers /
Roller Followers Heavy Duty Type



CAT-1582E

These follower bearings are designed for superior resistance against heavy loads and/or shock loads, incorporating full complement of cylindrical rollers in double rows.

Mini-Cam

Miniature Cam Followers



CAT-1582E

The miniature Cam Followers, including the world's smallest size 2, are suitable for high precision cam mechanisms and linear motion mechanisms found in electric parts manufacturing, inspection measuring instruments and OA equipment. Stainless steel models are highly resistant to corrosion and are best suited for environments exposed to water splashes or in clean rooms.

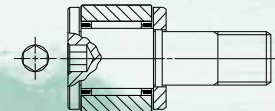



Maintenance-Free C-Lube Bearings with

Machined Type Needle Roller Bearings and Cam Followers



CAT-1581E



NART



C-Lube Unit for Cam Follower

Solid Lubricant Oil

It's Okay to Forget about Maintenance with C-Lube

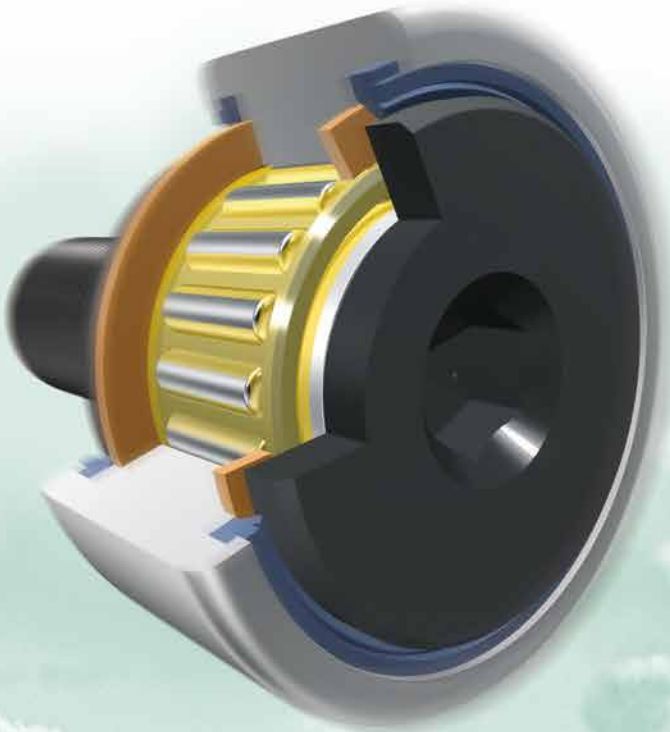

🔧 C-Lube bearings are revolutionary bearings with a prepacked thermosetting solid lubricant (C-Lube) inside. A large amount of lubricant and fine particles made of ultra-high molecular weight polyolefin resin are solidified by heat treatment to fill the inner cavity of the bearing. As the bearing rotates, the lubricant is deposited in the right amount onto the raceway, maintaining proper lubrication for a long period of time. C-Lube bearings are a great solution for those hard to reach spots on machines and equipment that never seem to get greased and are easy to forget. C-Lube bearings also reduce the time needed to manage a lubrication schedule. Cam Followers and Machined Type Needle Roller Bearings are both available with C-Lube.



C-Lube Cam Follower
CF.../SG



Machined type · Shell type
C-Lube Bearing

Your Secret Weapon ... Our Technical Expertise

KT...EG / KTZ...EGS / KTV...EG

Needle Roller Cages for Engine Connecting Rods



Developed calculation standards

- By consulting on R&D with customers, we established standard pressure on the bearing
- Safety factors, basic rated life, total life and pV rate also established

Provide support for joint development

- Developed split type cages
- FEM (Finite Element Method) analysis to calculate rigidity of needle cage

Top rated technical support

- Available during R&D stage or when machines are in the market to solve customer issues
- Evaluate, report and make suggestions for durability tested bearings
- Evaluate and suggest solutions for problems in the market
- Examine used oil for analysis of contained metal, ferrograph analysis, pollution level, etc.

CAT-1581E



What are Endless Design Possibilities Worth?

■ Spherical Bushings & PILLOBALLs



CAT-1581E



There are a wide range of sizes and types of  Spherical bushings for optimum design flexibility in a variety of applications.

 PILLOBALLs are compact self-aligning spherical bushings which can support a large radial load and a bi-directional axial load simultaneously. They are used in control and link mechanisms for machine tools, textile machines, packaging machines, among others. Metric and inch units are available in both series.

Available bore diameter:
3 mm to 300 mm

A photograph of two salmon jumping out of the water in a stream. The water is turbulent and white with foam. The salmon are in mid-air, their bodies curved as they move upwards and to the right. The background is a dark, rocky stream bed.

***Go Straight
This Way***

Linear Motion Rolling Guides

IICO Linear Motion Rolling Guides are used for applications that require precision motion and positioning such as semi-conductor manufacturing equipment and large-sized machine tools. In contrast to conventional rolling bearings used in rotating parts, Linear Motion Rolling Guides can meet the increasing need for precise linear motion in precision positioning machines and equipment, such as plane sliding mechanisms. Rail guided Linear Ways and Linear Roller Ways, shaft guided Linear Ball Splines, and other IICO products are recognized for their high quality and excellent features.

Integrated Lubrication	23
Maintenance Free C-Lube Linear Way ML	25
Maintenance Free C-Lube Linear Roller Way Super MX	27
Maintenance Free C-Lube Linear Ball Spline	29
Linear Roller Way Super X	31
Super Micro & Miniature Linear Ways	33
Linear Ball Spline	34
Precision Linear Slide	35
U-Shaped Track Rail Linear Ways	37
Linear Ways for Special Environment	39
Anti-Creep Cage Crossed Roller Ways	41



The World's First Linear Guides with Integrated Lubrication

C-Lube



IKO Clean Lubrication

C-Lube 
Friendly to Maintenance
Gentle to the Earth

Maintenance-Free C-Lube Offers Both Lower Installation Cost and Lower TCO

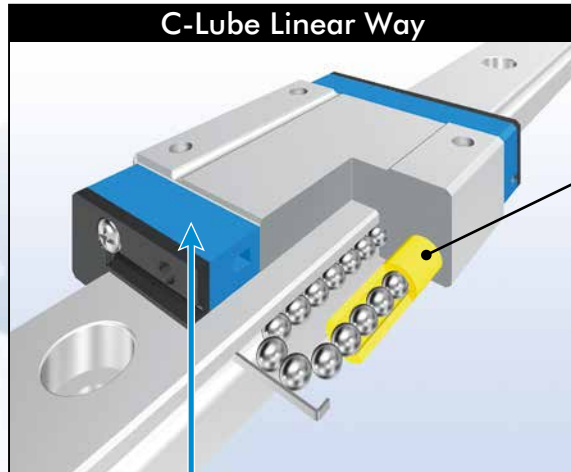

The aquamarine end-plate is the symbol of maintenance free.

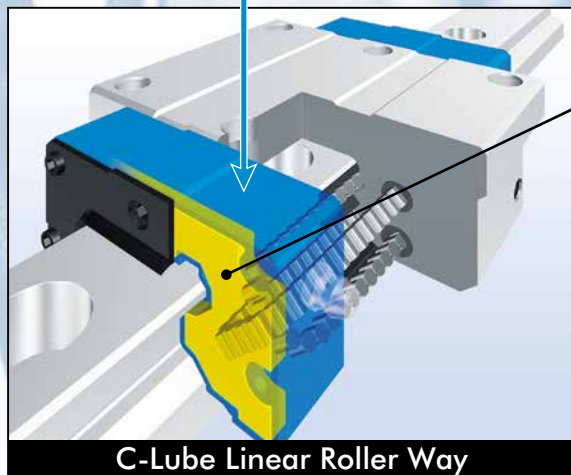

C-Lube Integrated

Lubrication oil is carried through circulation of the rolling elements

The lubrication oil is supplied directly to the rolling elements, not the track rail. When the rolling elements make contact with the C-Lube element integrated in the circulation path of the slide unit, the lubrication oil is supplied to the surfaces of the rolling elements and distributed to the contact area of the track rail. This provides the right amount of lubrication at the contact area. C-Lube has been tested to provide maintenance-free operation for at least 20,000km.

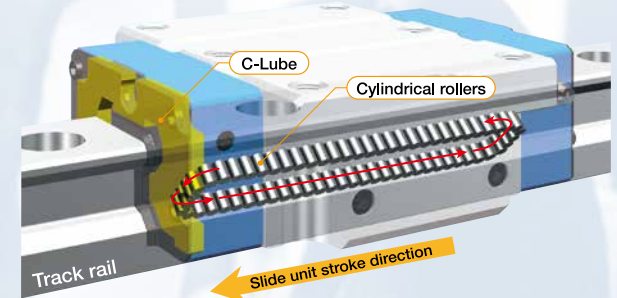

Lubrication oil is supplied directly to the surface of the rolling elements

Due to the unique porous sintered resin material used in C-Lube, it is capable of holding sufficient amounts of lubrication oil. The lubrication oil is then continuously supplied to the surface of all rolling elements by surface tension in contact with the surface of the capillary lubricating element. The capillary action in the lubricating element ensures adequate amounts of oil are supplied at the surface, maintaining proper lubrication at all times.

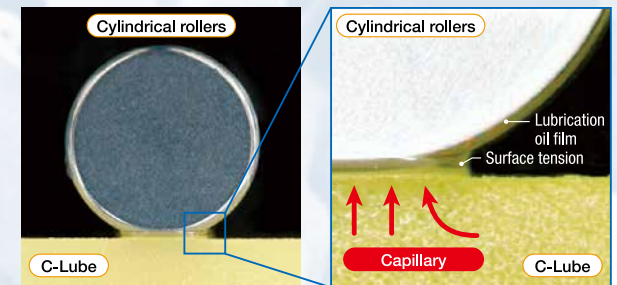



ML

Maintenance Free
C-Lube Linear Way ML



CAT-1578E

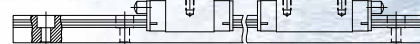

ML

IKO Super Precision, Maintenance-Free Miniature Linear Guides

IKO C-Lube Linear Way ML is a light-weight and compact Linear Way that incorporates C-Lube technology for long-term, maintenance-free operation.

Maintenance-Free

Since the lubrication oil inside C-Lube can maintain the lubrication performance for a long time, it reduces lubrication management schedules and the work associated with them.

Lightweight and Compact

Since C-Lube is incorporated within the Linear Way ML, it maintains its lightweight, compact size without changing the external dimensions (dimensionally the same as LWL series).

Smooth and Light Running

C-Lube is not in contact with the track rail. This permits smooth and light slide motion without increasing the rolling resistance.

Stainless Steel Components

The material components of the C-Lube Linear Way ML are made from corrosion resistant stainless steel. This makes the units most suitable for applications in special environments and where lubricants and corrosion protection oils are prohibited.

Ball Retained Type

For easier mounting on machines and equipment, the slide units have steel ball retaining bands incorporated within its structure to prevent the loss of the rolling elements (balls) when the slide unit is removed from the track rail.



Available track rail width:
5 mm to 42 mm



MX

Maintenance Free C-Lube
Linear Roller Way Super MX

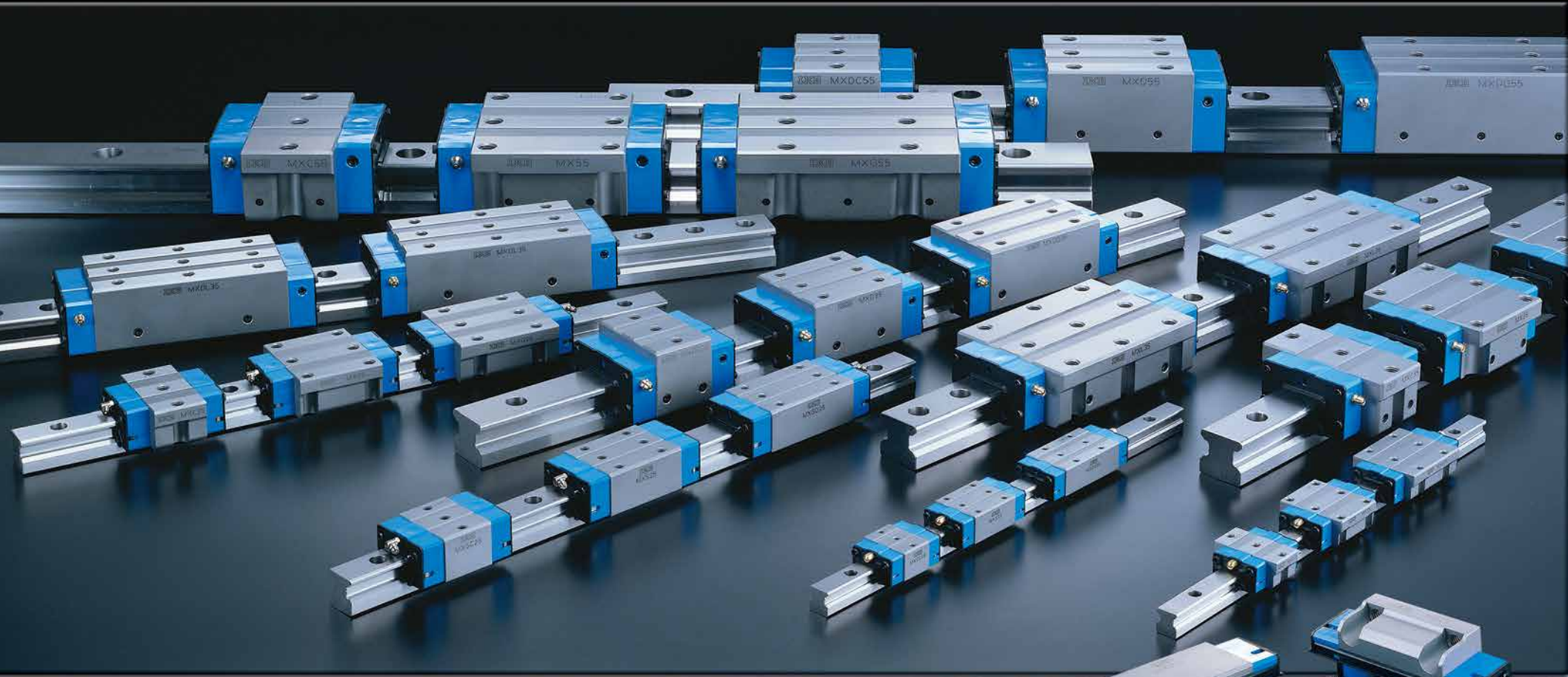

CAT-1578E

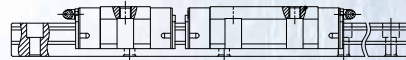
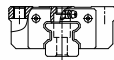

MX



Integrating Knowledge and Responsibility for the Benefit of All

Power & Balance

Roller Effects

A well balanced structure with cylindrical rollers as rolling elements for greater load capacity, very high-rigidity, superior running accuracy and excellent damping characteristics. C-Lube Linear Way Super MX is the best product for machine tool applications that require high machining accuracy under high speed cutting, heavy cutting with vibration and shocks, or precision grinding.

Maintenance-Free

With built in C-Lube technology, the capillary system continuously supplies the proper amount of lubrication oil to the cylindrical rollers, keeping the raceways well lubricated for a long period of time. C-Lube has been tested to run maintenance-free for 20,000km and beyond.

Interchangeable

Since the slide units and track rails are supplied separately, they can be matched, replaced and added freely. This interchangeability provides more freedom in designing machines, accommodating both standardization or sudden changes to specifications.

Available track rail width:
10 mm to 65 mm

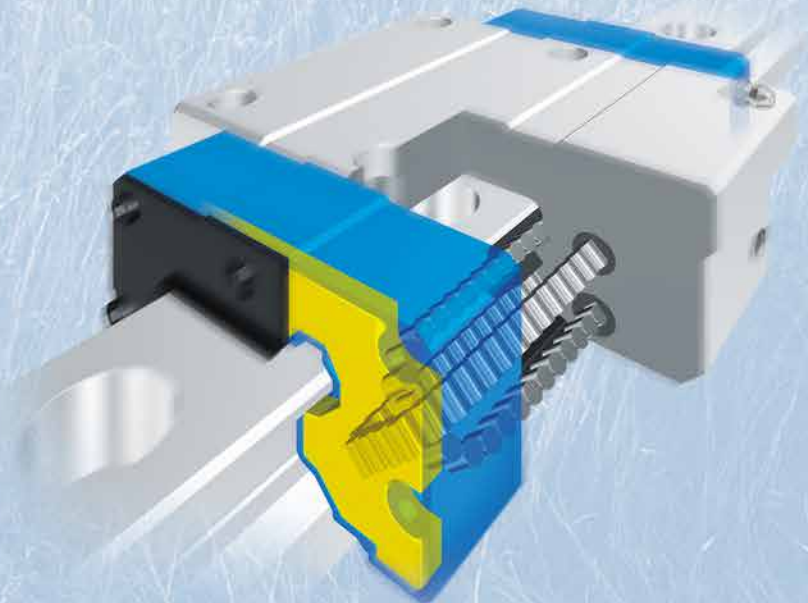



MAG

Maintenance Free
C-Lube Linear Ball Spline



CAT-1579E



MAG

Maintenance-Free for 200 Million Cycles or More

Lubricant is incorporated in the compact external cylinder

Incorporating the C-Lube lubrication component in the steel ball circulating path of the external cylinder can provide maintenance-free operation for 20,000km and more. With C-Lube technology, the cost of the whole system can be reduced as a result of a reduction in required lubrication, running cost and the reduction in hours spent on lubrication maintenance.

High-rigidity and high-accuracy, in spite of the compact size

A simple two-row, four-point contact structure using large diameter steel balls provides compactness, high-rigidity, high-accuracy and lower cost.

Available shaft diameter:
4 mm to 12 mm



The C-Lube System

Circulation of steel balls distributes the lubricant

Lubricant is supplied directly to the steel balls. As the steel balls circulate, the lubricant is distributed to the loading area along the spline shaft. This results in adequate lubrication being properly maintained in the loading area for a long time.

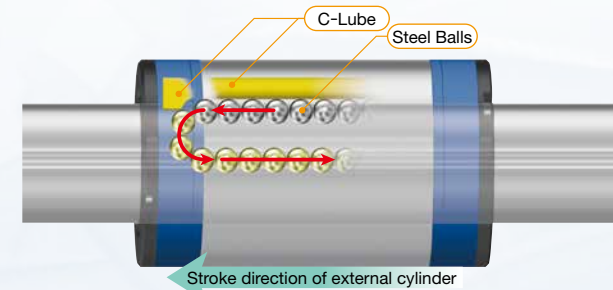

Lubricant is deposited directly to the surface of the steel balls

Lubricant is continuously supplied to the surface of the steel balls through surface tension between contact of the C-Lube surface and the steel balls. New oil permeates automatically from the core of C-Lube to the internal surface that comes in contact with the steel balls.

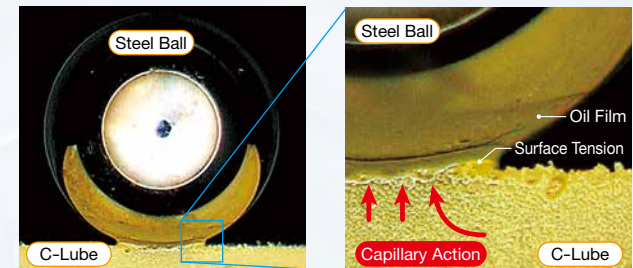



LRX

Linear Roller Way Super X



CAT-1578E

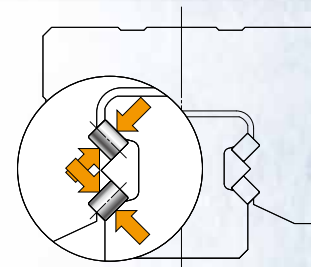

The Roller Effect Monster

SKF Linear Roller Way Super X has four rows of well balanced cylindrical rollers incorporated in a highly rigid casing. The cylindrical rollers in each row are arranged in parallel to each other. Small elastic deformation and stable operation is ensured, even under heavy or fluctuating loads.

Excellent Rigidity

Superior Running Accuracy

Great Damping Characteristics

The Super X interchangeable series has the “Six Roller Effect”, providing more potential for your application.

High Load Capacity and Long Life

Smooth and Quiet Motion

Available in Stainless Steel

The SKF Linear Roller Way Super X series offers high-rigidity and high load capacity. The smallest size, LRX 10, is the newest addition and expands the range of options. Interchangeable, stainless steel made, and nineteen different special options are also available.

Available track rail width:
10 mm to 100 mm



The Ultimate Miniature Technology for Micro Machines



LWL1

Micro Linear Way LWL

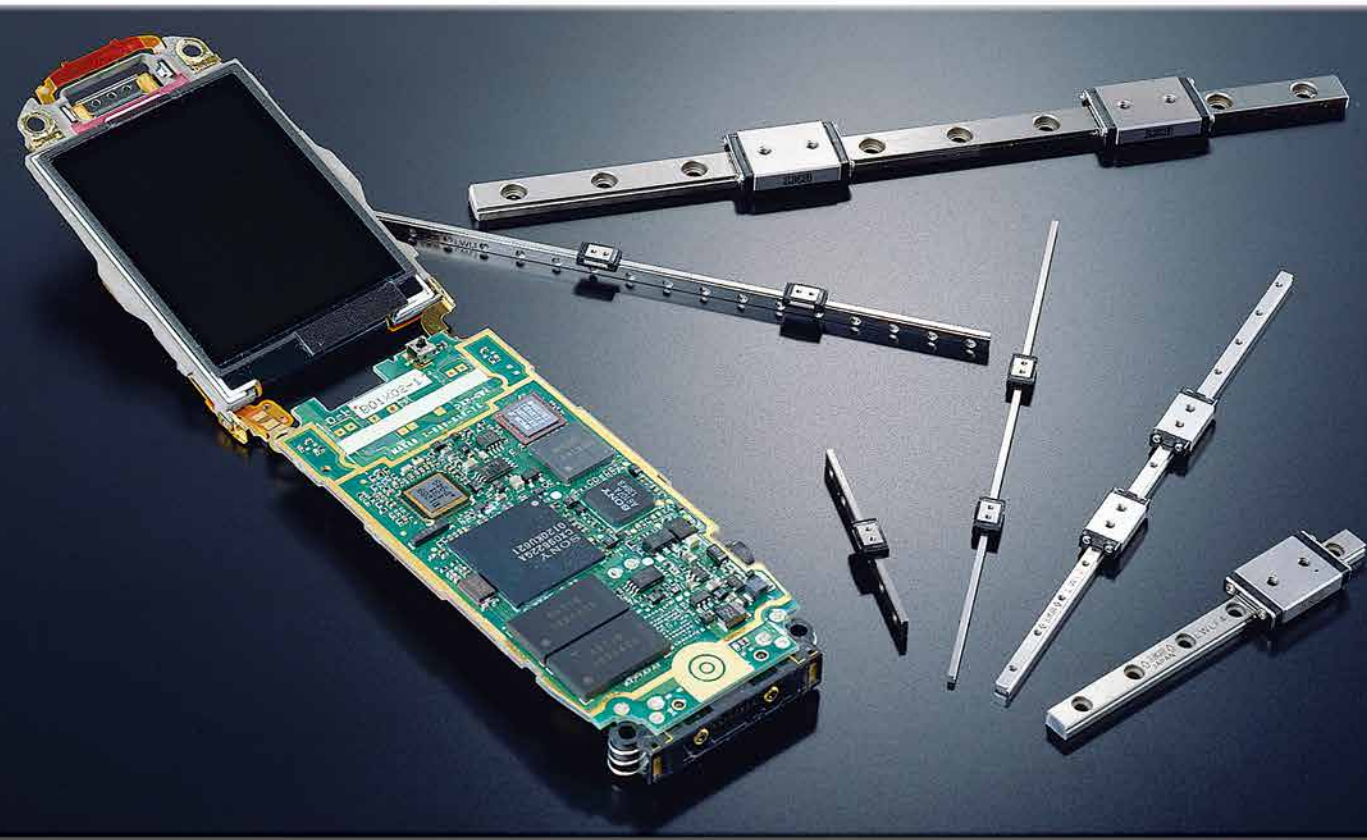

CAT-1578E

A super micro size of just 1 mm width means endless possibilities! Product accuracy is the same as our other sizes since all dimensional tolerances are controlled by the same strict precision manufacturing technology and standards. This is the smallest linear motion rolling guide  offers, and they are ideal for applications where compactness and high capacity are required.

Available track rail width:
1 mm to 42 mm

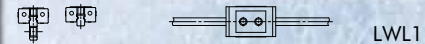

LWL1





LSAG

Interchangeable Linear Ball Spline G



The  Angular Type Linear Ball Spline G series has a compact ball spline with an external cylinder that has a small outside diameter thanks to a two row raceway with four point ball contact structure. This series is suitable for applications that require smooth linear motion and accurate angular positioning, such as Z-axis or IC/liquid crystal manufacturing systems, industrial robots, OA equipment, measuring instruments, etc.

Available shaft diameter:
2 mm to 40 mm

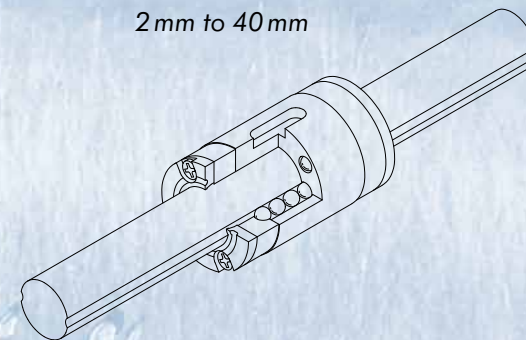

CAT-1579E



Great Opportunities Come in Small Packages

BSP · BSPG · BSR

Precision Linear Slide



The  Precision Linear Slide series are miniature type linear motion rolling guides comprised of a U-shaped table and bed (or track rail) made from a stainless steel sheet by precision forming. They are compact and lightweight, and achieve smooth and accurate linear motion along their precision ground raceways.

CAT-1579E





BWU

Precision Linear Slide Unit



The **BWU** Precision Linear Slide Unit series are compact linear motion rolling guides with a limited stroke length. The BWU series are available in a wide range of sizes, with BWU 6 the smallest. All parts are made from stainless steel, so this series is corrosion resistant and suitable for clean room use.

CAT-1579E





LWU

U-Shaped Track Rail Linear Way



CAT-1578E

U Will Create Something Really Innovative

The high-rigidity U-shaped track rail does not require a base mounting bed so it can be used as a structural member of the machine. Either in a cantilever position or supported at both ends, this product provides cost savings and time savings thanks to its mounting method and assembly.

Available track rail width:
25 mm to 130 mm

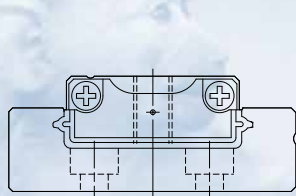

LWUL

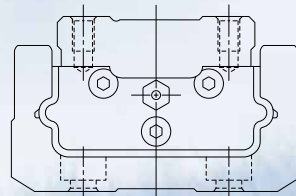

LWU

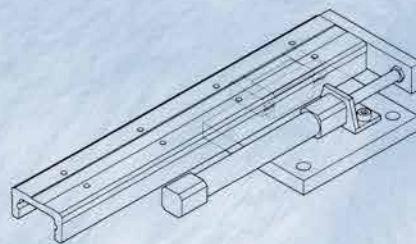
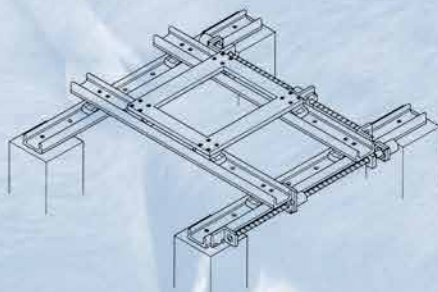
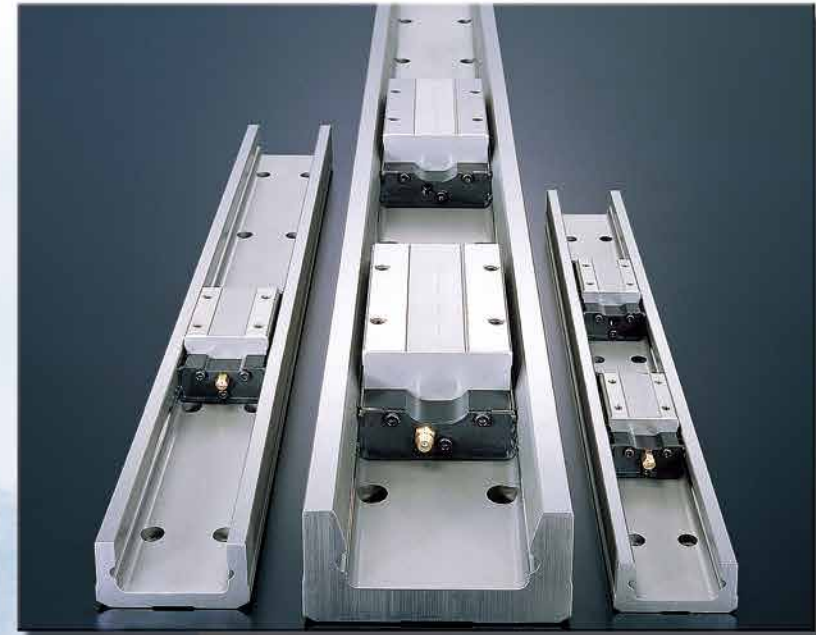

Solutions for Products That Need Some Extra Help



The Linear Way for Special Environments

Guide to Optional Parts



CAT-1578E

High temperature conditions, adhesion of welding spatter, fine particles in the air, rusty conditions, clean and vacuum environments, etc. To meet the requirements under these conditions and ensure stable performance for long periods of time, Linear Ways can be modified with optional special parts based on individual specifications.



Linear Motion Rolling Guide Series with Capillary Plate for Lubrication



CAT-1578E

An  Capillary Plate can be attached to the slide unit of the Linear (Roller) Way, making uniform contact with the track rail raceway. Lubrication oil impregnated in the Capillary Plate is continuously fed to the raceway when the slide unit travels along the track rail. Re-lubrication intervals can be longer, and maintenance and inspection times can be reduced.

For the Latest Advanced Technology Fields



C-Lube Linear Way ML

Ceramic Ball Specification



CAT-1578E

Features

- 1 **High speed operation**
— Three times as durable
- 2 **Low running noise**
— Decrease of approximately 4.5db
- 3 **High-rigidity**
— Deformation improved by 10%
- 4 **High wearing resistance**
— Initial wear improved by 1/4 less



Linear Motion Rolling Guide

Non Magnetic Series



CAT-1578E

Non-magnetic material is suitable for semiconductor and liquid crystal manufacturing equipment that may be operated within special magnetic fields or when using electron beams.

Freedom and Control

The perfect solution for cage creep issues thanks to a built in rack and pinion mechanism - an  original design.



Features

- 1 Freedom in mounting**
— This series is ideal for applications where vertical axis mounting is necessary and an existing Crossed Roller Way is not easy to use
- 2 Reliable in high-speed and high-tact use**
— No corrective action for cage creeping is necessary, even over long-time operation
- 3 Energy-saving**
— No cage creeping even with high-tact operation

Available roller diameter:
2 mm to 6 mm



A white bird, possibly a cockatoo, is shown in flight against a blue background. The bird's wings are spread wide, and its tail feathers are visible. The bird is positioned on the right side of the frame, flying towards the left. The background is a solid blue color.

Endless Opportunities
... Limitless Possibilities

Precision Positioning Tables

IKO Precision Positioning Tables were developed by merging together the technology of Linear Motion Rolling Guides, which has been innovated and fostered at **IKO** for many years, with the most advanced micro electronics technology.

IKO Precision Positioning Tables are widely used as high-performance positioning mechanisms in not only various measuring instruments, work machines and assembling machines, but also in the most advanced liquid crystal/semiconductor manufacturing systems. Their superior performance has been proven through use in these highly demanding applications.

Single Axis Precision Positioning Tables	45
Super Precision Positioning Tables	47
High Rigidity and Large Load Capacity Tables	48
Linear Motor & Nano Linear Tables	49
Alignment Stages	51
Compact Tables	52
Precision Elevating Tables	54



For information on products in this section,
ask for catalog [CAT-1580E](#).

Making Your Action More Precise



This series is available in eight sizes with a track rail width ranging from 25 mm to 130 mm and different length slide tables. The type and lead of ball screw, motor type, sensor installation and X-Y stage assembling can also be selected to obtain the optimal positioning table for each specific application. A low profile type is available, as well as a new longer stroke model.

Available table width :

TU : 25 mm to 130 mm

TE : 50 mm to 86 mm

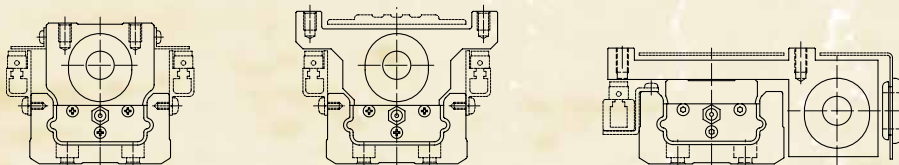



TX & CTX

Super Precision Positioning Table



CAT-1580E



1 High reliability and stability against fluctuating loads

— High-rigidity and high load capacity are realized by incorporating Linear Roller Way Super X on a rigid body made of cast iron. Deflection level against load and mass are minimal and high stability operation is possible, even under fluctuating loads.

2 Use in vacuum conditions

— Possible to use in vacuum environments where an air slide could not be used because of negative air affect. Vacuum environment grease is available on request.

3 For clean room applications

— Low dust generating clean grease is available as an option.

4 Simple construction

— The system configuration is very simple since this positioning table does not require an air supply device for driving. This also helps to save on space and cost.

IKO TX is a Super Precision Positioning Table. With IKO Linear Roller Way Super X as the guidance component, it provides super high running accuracy and high load capacity. Epoch-making 5-micron meter of positioning accuracy is possible with a full closed-loop control system. This series is suitable for applications where a high level of running accuracy is required and conventional rolling type positioning tables cannot be used.

TSLH & CTLH

High Rigidity and Large Load Capacity Table

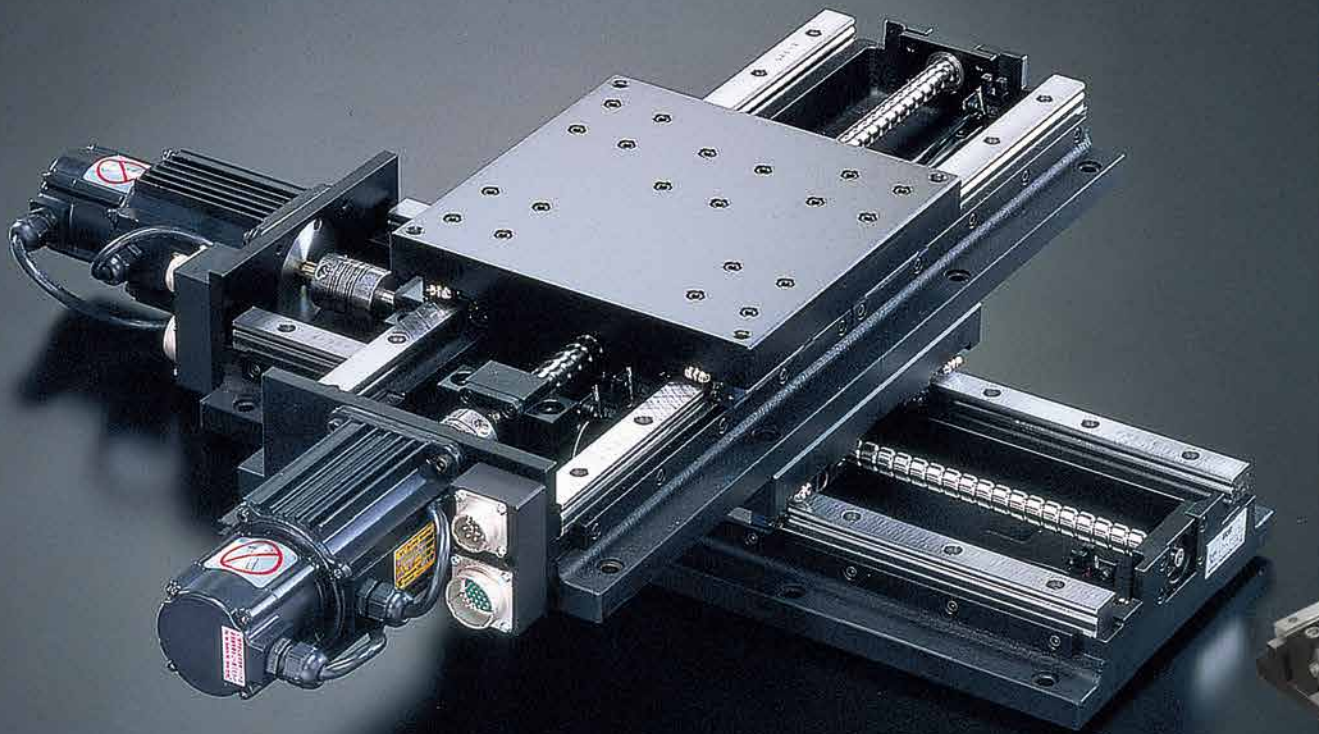

The TSLH and CTLH offer high-rigidity, high load capacity and a cast iron body with superior damping characteristics. The series includes an extra-large size with a table width of 420 mm. The single axis TSLH and X-Y axes CTLH provide stable and high running accuracy and positioning.



CAT-1580E



Vision is the Art of Seeing the Invisible



LT

Linear Motor Table

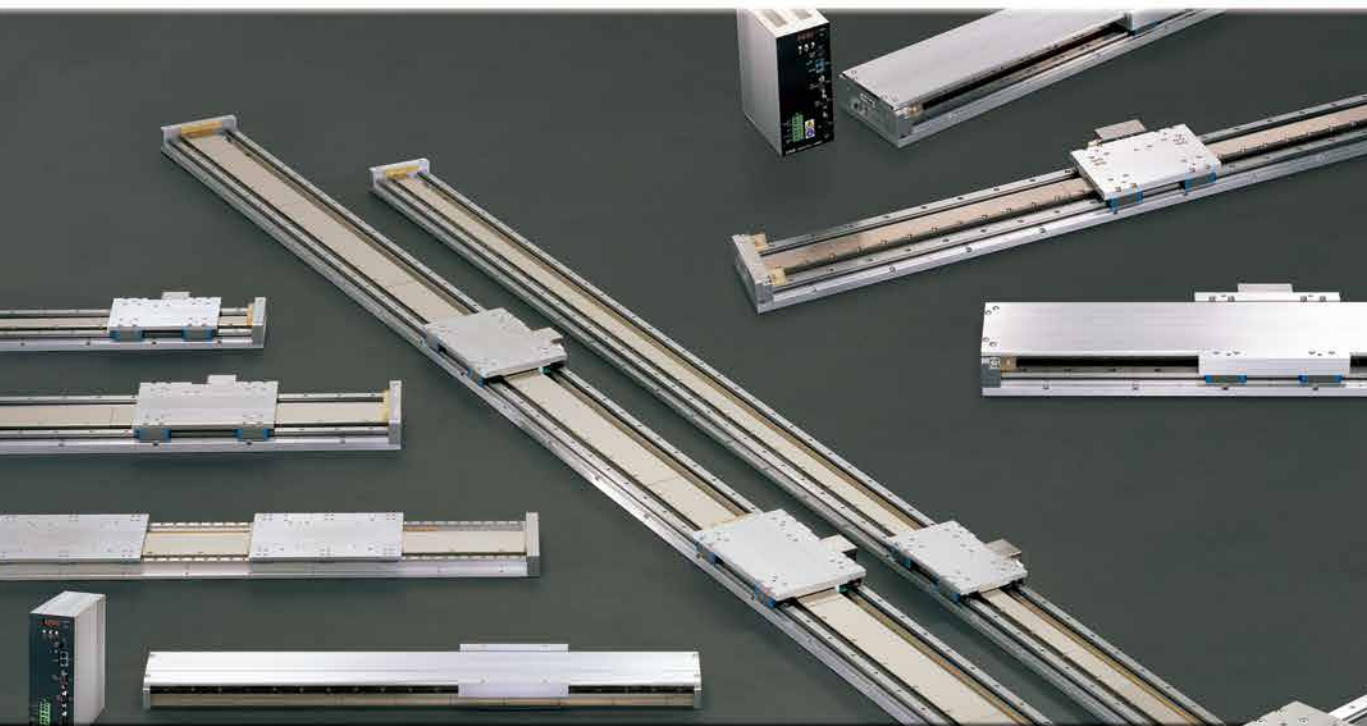

Linear Motor Table LT is a light weight direct drive positioning table with a low sectional height. An AC linear servo motor and an optical linear scale are compactly integrated in the moving table and bed made of aluminum alloy. Linear Motor Table LT has a C-shaped magnet yoke between two stator magnets with a moving coil that provides a large driving force and achieves high speed and quick response positioning.

Height of table : 40 mm
Maximum stroke length : 2760 mm
Maximum speed : 3 m/sec
Maximum thrust : 900 N

CAT-1580E

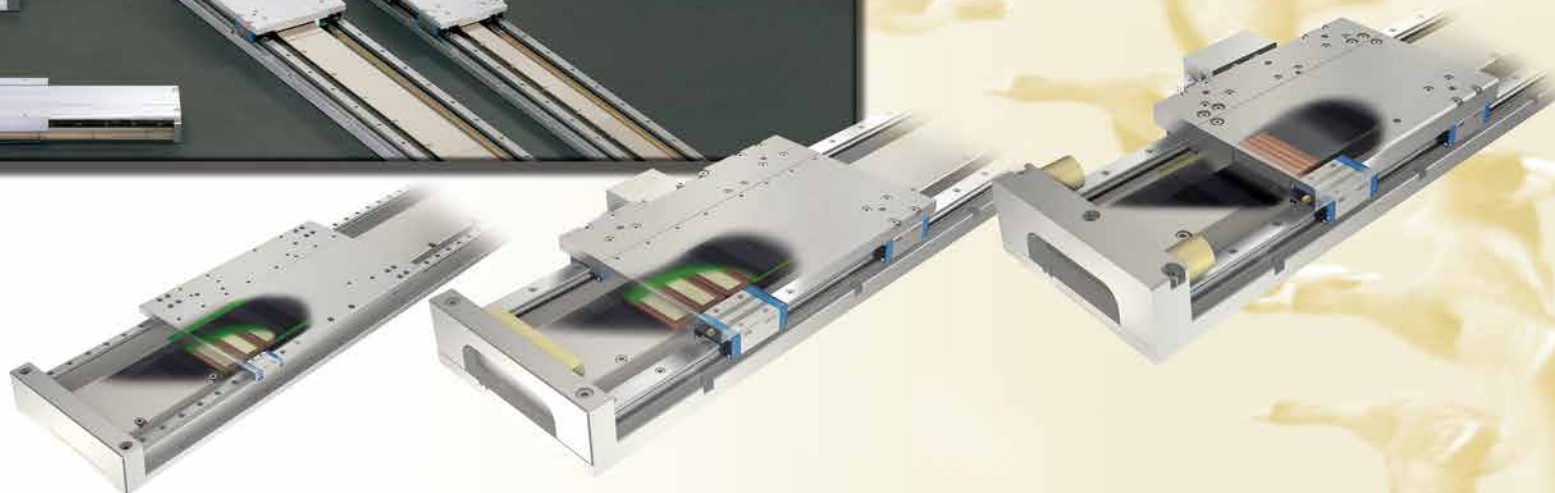



NT

Nano Linear

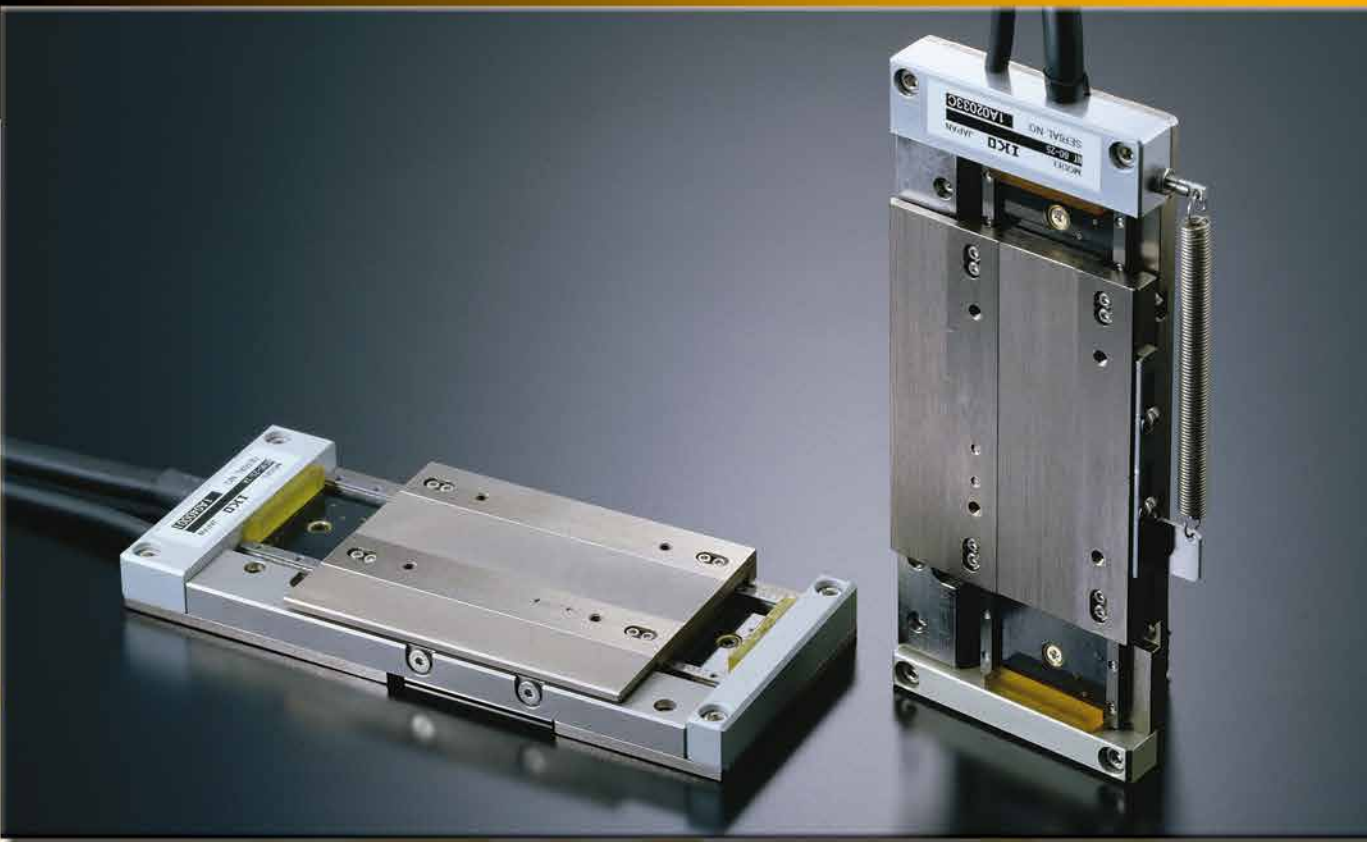

CAT-1580E

Nano Linear NT incorporates moving magnets and an optical linear scale in a steel moving table that also functions as a magnet yoke. The arrangement features stator coils and a linear scale sensor as a compact unit on the steel bed that also functions as a coil yoke. It has an epochal structure requiring no moving cables since the linear scale sensor is arranged on the bed. This provides a high level of cleanliness since little dust is generated.

- 1 Ultra compact size with a height of 14 mm
- 2 Excellent clean performance
- 3 Super acceleration/deceleration and quick response
- 4 Superior rest stability and speed stability





SA-M

Alignment Stage Module



This low profile, large platform precision positioning stage has alignment modules arranged at four locations on the same plane as the angle alignment mechanisms. This stage can perform X-Y- θ motion, and is suitable for large panel alignment requiring high-rigidity.



CAT-1580E

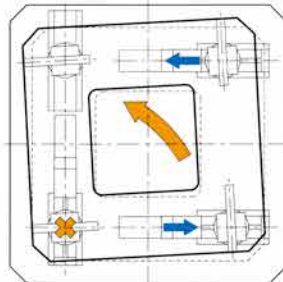
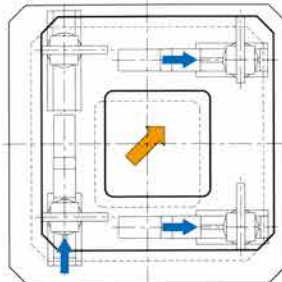



TS & CT

Compact Table

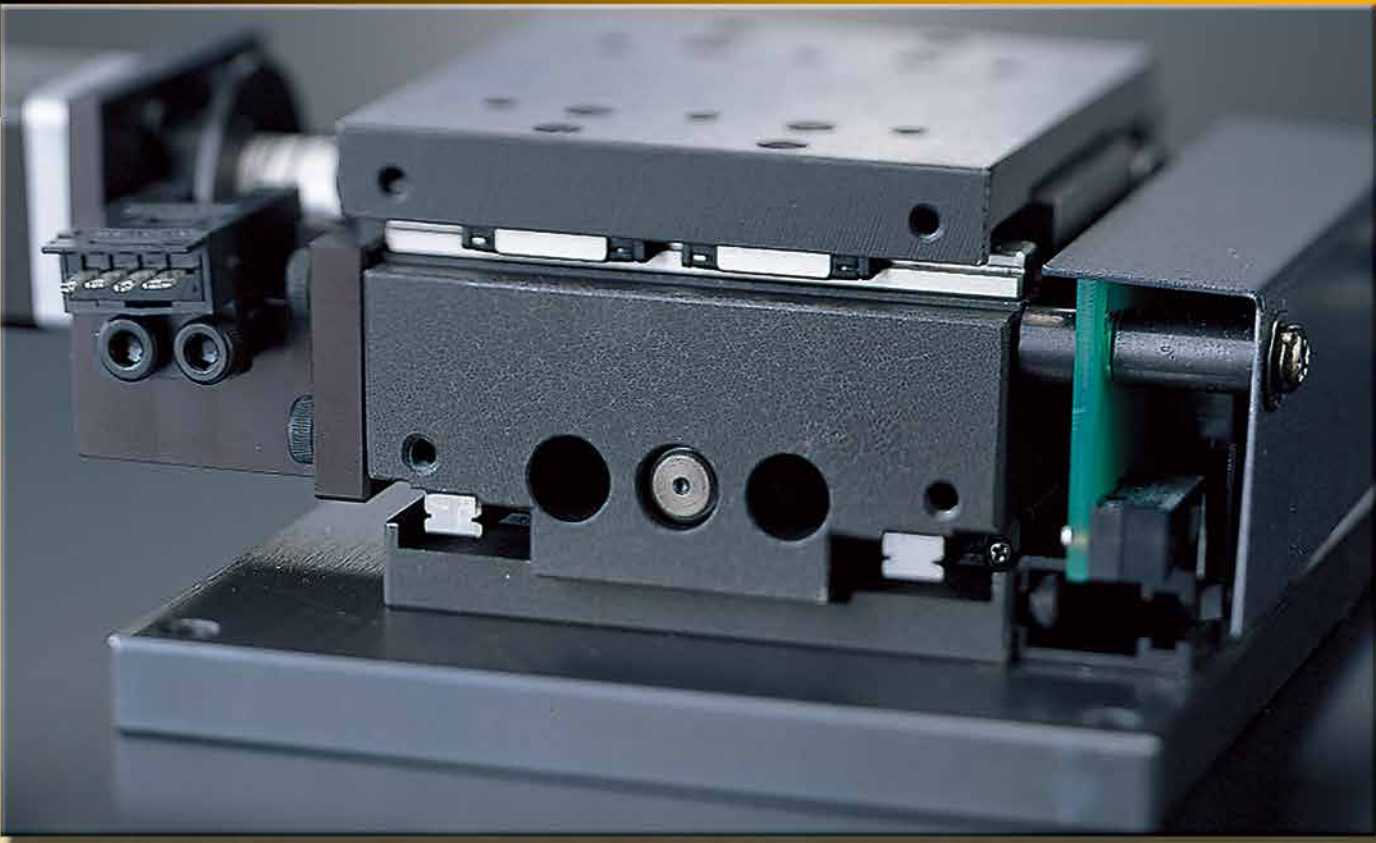

Compact tables with a low sectional height of 40 mm are available. High performance $\mathbb{R}\mathbb{R}\mathbb{R}$ Linear Motion Rolling Guides are assembled into the main body made of cast iron for superior rigidity and excellent damping characteristics. Positioning accuracy of 5-micron meter is possible.

CAT-1580E





AT

Alignment Table



CAT-1580E

Best suited for precision angle correction mechanisms. Sensors are included as the standard specification and provide high repeatability (+/- 1 sec). Table diameters of 120 mm, 200 mm and 300 mm are available.



TC

Clean Room
Precision Positioning Table



CAT-1580E

The best choice for environments that require a high level of cleanliness, such as semiconductor manufacturing equipment and liquid crystal related equipment. Clean class 2 or 3 (Federal Standard 209D Class 1) are possible.

Slim and Super-tight-sealing type

Cleanliness level
JIS class 2 **TC···US**

Wide and High-rigidity type

Cleanliness level
JIS class 3 **TC···U**

Wide and Full-covered type

Cleanliness level
JIS class 3 **TC···L**



TSL···M

Long Stroke Precision Positioning Table



CAT-1580E

High running accuracy is achieved by incorporating two sets of Linear Ways in parallel. A slide table and bed made of a high-strength aluminum alloy are used to reduce the total weight. Stroke lengths up to 1,000 mm are available.



Precision Elevating Table



Performs precision positioning in the vertical direction by using a wedge mechanism. The unique wedge mechanism provides both high accuracy and high-rigidity in a very compact size.

CAT-1580E

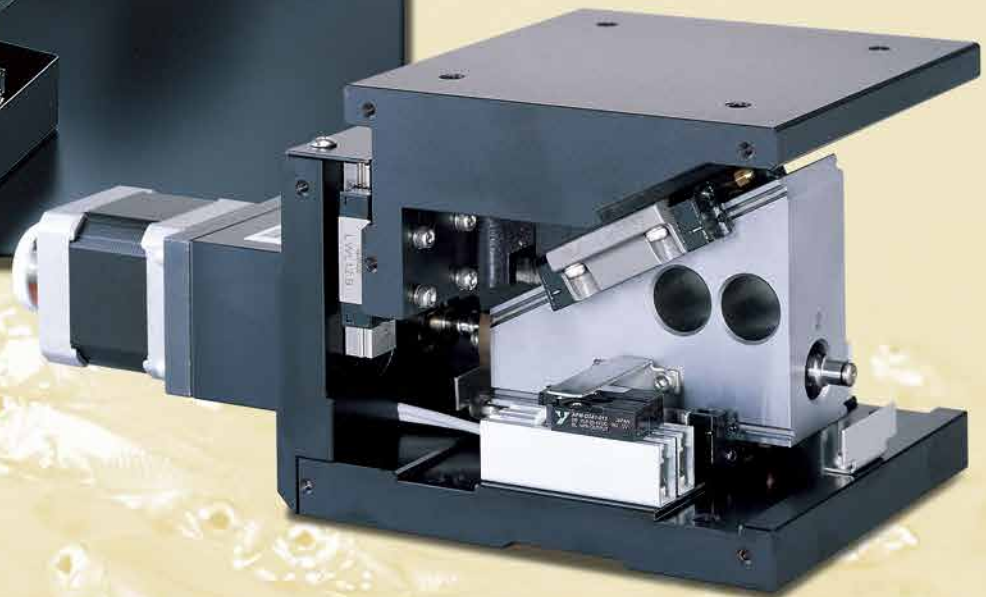



Listen to the Wind
It's the Voice from the Earth

We've got to Give the Earth a Chance

At **IKEA**, we recognize that the conservation of the global environment is the most important challenge all human beings face. As part of our corporate social responsibility, we will help foster a rich global environment through activities that reduce negative impacts on the environment.

IKEA Clean Lubrication

C-Lube 
Friendly to Maintenance
Gentle to the Earth

Your Partner for Today and Tomorrow

At IKO, we aim to be a company centered on technology development that focuses our expertise and passion into meeting customer needs. With our original technologies and product innovations, we have set ourselves apart from the competition. We will continue to grow, innovate, and develop new technologies and technical skills that drive excellent motion performance, while serving our customers to help improve their business.

*ISO 9001 & 14001 Quality system
registration certificate*



IKO INTERNATIONAL, INC.

<https://www.ikont.com/>

East Coast Operations

Fox Hill Ind. Park, 91 Walsh Drive
Parsippany, NJ 07054
E-mail : eco@ikonet.co.jp
Phone : +1 (973) 402-0254
Toll Free: +1 (800) 922-0337
Fax : +1 (973) 402-0441

Southeast Operations

2150 Boggs Road, Suite 100
Duluth, GA 30096
E-mail : seo@ikonet.co.jp
Phone : +1 (770) 418-1904
Toll Free: +1 (800) 874-6445
Fax : +1 (770) 418-9403

Southwest Operations

8105 N. Beltline Road, Suite 130
Irving, TX 75063
E-mail : swo@ikonet.co.jp
Phone : +1 (972) 929-1515
Toll Free: +1 (800) 295-7886
Fax : +1 (972) 915-0060

Midwest Operations

101 Mark Street, Unit-G
Wood Dale, IL 60191
E-mail : mwo@ikonet.co.jp
Phone : +1 (630) 766-6464
Toll Free: +1 (800) 323-6694
Fax : +1 (630) 766-6869

Minnesota Sales Office

1500 McAndrews Road West, Suite 210
Burnsville, MN 55337
E-mail : mwo@ikonet.co.jp
Phone : +1 (952) 892-8415
Toll Free: +1 (800) 323-6694
Fax : +1 (952) 892-1722

West Coast Operations

9830 Norwalk Blvd., Suite 198
Santa Fe Springs, CA 90670
E-mail : wco@ikonet.co.jp
Phone : +1 (562) 941-1019
Toll Free: +1 (800) 252-3665
Fax : +1 (562) 941-4027

Silicon Valley Sales Office

1500 Wyatt Dr., Suite 10
Santa Clara, CA 95054
E-mail : wco@ikonet.co.jp
Phone : +1 (408) 492-0240
Toll Free: +1 (800) 252-3665
Fax : +1 (408) 492-0245

